

# DC170 Document Camera

## User Manual - English

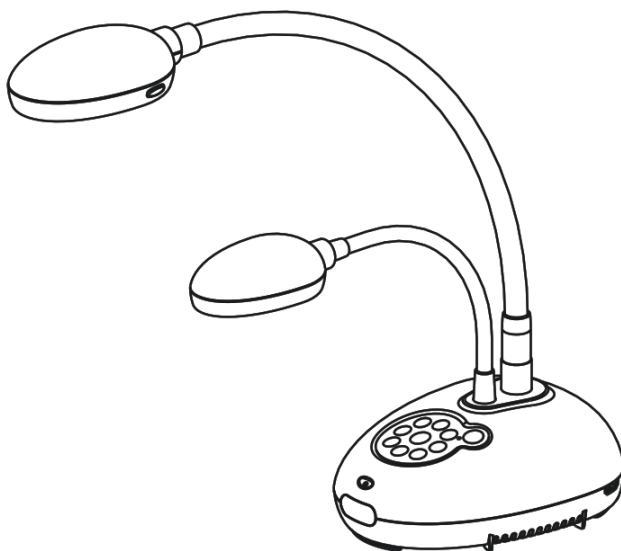

### [Important]

To download the latest version of Quick Start Guide, multilingual user manual, software, or driver, etc., please visit Lumens  
<http://www.Mylumens.com/goto.htm>

# Table of Contents

<b>Copyright Information</b> .....	<b>3</b>
<b>Chapter 1 Safety Instructions</b> .....	<b>4</b>
Precautions .....	5
FCC Warning.....	5
EN55022 (CE Radiation) Warning .....	5
<b>Chapter 2 Package Contents</b> .....	<b>6</b>
<b>Chapter 3 Product Overview</b> .....	<b>7</b>
3.1 Relative position of the presenter and document .....	8
<b>Chapter 4 Installation and Connections</b> .....	<b>9</b>
4.1 System diagram .....	9
4.2 Installation and setup .....	10
4.3 Connecting to a projector or monitor .....	10
4.4 Connecting to a computer and use Lumens™ software .....	11
4.5 Connecting to a computer and projector or monitor simultaneously .....	11
4.6 Connect to a PC and read the SD card.....	12
4.7 Connecting to an Interactive Whiteboard (IWB).....	12
4.8 Connecting to an HDTV .....	13
4.9 Connecting to a speaker .....	13
4.10 Connecting to a Computer with RS232.....	14
4.11 Connecting to a TV .....	14
4.12 Installing application software .....	15
<b>Chapter 5 Start Using</b> .....	<b>16</b>
<b>Chapter 6 Control Panel/Remote Control and Setting Menu</b> .....	<b>17</b>
6.1 Functions of control panel and remote control .....	17
6.2 Setting Menu.....	19
<b>Chapter 7 Descriptions of major functions</b> .....	<b>24</b>
7.1 I would like to automatically adjust the image to have the best brightness and focusing performance .....	24
7.2 I would like to switch image sources .....	24
7.3 I would like to switch the image mode.....	24
7.4 I would like to make text clearer and photos more colorful .....	24
7.5 I would like to zoom in/out images .....	25

7.6	I would like to use the auto focus .....	25
7.7	I would like to adjust the brightness .....	25
7.8	I would like to turn on/off the lamp .....	25
7.9	I would like to freeze images .....	26
7.10	I would like to rotate the image .....	26
7.11	I want to capture images .....	26
7.12	I would like to record videos .....	27
7.13	I would like to view captured/recorded images .....	28
7.14	I would like to delete the captured/recorded images .....	29
7.15	I would like to automatically delete the stored images whenever it is turned off (Auto Erase) .....	29
7.16	I would like to enlarge a part of the image (PAN) .....	29
7.17	I would like to use the MASK and Spotlight function .....	30
7.18	I would like to play the slides (Slide Show) .....	31
7.19	I would like to compare images (compare live images with stored images (PIP)) .....	31
7.20	I would like to reduce the image noise (Projector Type) .....	32
7.21	I would like to resume the factory default settings (Factory Reset) .....	32
7.22	I would like to change the splash screen .....	33
7.23	I would like to use a SD card .....	34
7.24	Computer-related functions .....	34
<b>Chapter 8</b>	<b>Connecting to Microscope .....</b>	<b>36</b>
<b>Chapter 9</b>	<b>DIP Switch Settings .....</b>	<b>37</b>
9.1	Connecting to a projector or monitor .....	37
9.2	Connecting to a TV .....	38
<b>Chapter 10</b>	<b>Troubleshooting .....</b>	<b>39</b>

# Copyright Information

---

Copyrights © Lumens Digital Optics Inc. All rights reserved.

Lumens is a trademark that is currently being registered by Lumens Digital Optics Inc.

Copying, reproducing or transmitting this file is not allowed if a license is not provided by Lumens Digital Optics Inc. unless copying this file is for the purpose of backup after purchasing this product.

In order to keep improving the product, Lumens Digital Optics Inc. hereby reserves the right to make changes to product specifications without prior notice. The information in this file is subject to change without prior notice.

To fully explain or describe how this product should be used, this manual may refer to names of other products or companies without any intention of infringement.

Disclaimer of warranties: Lumens Digital Optics Inc. is neither responsible for any possible technological, editorial errors or omissions, nor responsible for any incidental or related damages arising from providing this file, using, or operating this product.

# Chapter 1 Safety Instructions

---

Always follow these safety instructions when setting up and using the Document Camera:

1. Do not place Document Camera in tilted position.
2. Do not place the Document Camera on an unstable trolley, stand or table.
3. Do not use the Document Camera near water or source of heat.
4. Use attachments only as recommended.
5. Use the type of power source indicated on the Document Camera. If you are not sure of the type of power available, consult your dealer or local electricity company for advice.
6. Place the Document Camera on a place that it can be unplugged easily.
7. Always take the following precautions when handling the plug. Failure to do so may result in sparks or fire.
  - Ensure the plug is free of dust before inserting it into a socket.
  - Ensure that the plug is inserted into the socket securely.
8. Do not overload wall sockets, extensions leads or multi-way plug boards as this may cause fire or electric shock.
9. Do not place the Document Camera where the cord can be stepped on as this may result in fraying or damage to the lead or the plug.
10. Unplug the Document Camera from the wall socket before cleaning. Use a damp cloth for cleaning. Do not use liquid or aerosol cleaners.
11. Do not block the slots and openings in the Document Camera case. They provide ventilation and prevent the Document Camera from overheating. Do not place the Document Camera on a sofa, rug or other soft surface or in a built-in installation unless proper ventilation is provided.
12. Never push objects of any kind through cabinet slots. Never allow liquid of any kind to spill into the Document Camera.
13. Except as specifically instructed in this User Manual, do not attempt to operate this product by yourself. Opening or removing covers may expose you to dangerous voltages and other hazards. Refer all servicing to licensed service personnel.
14. Unplug the Document Camera during thunderstorms or if it is not going to be used for an extended period. Do not place the Document Camera or remote control on top of heat-emitting equipment or heated objects such as a car, etc.
15. Unplug the Document Camera from the wall outlet and refer serving to licensed service personnel when the following situations happen:
  - If the power cable or plug becomes damaged or frayed.
  - If liquid is spilled into it or the Document Camera has been exposed to rain or water.





**<Note> Using an incorrect battery type in the remote control may result in breakdown. Follow your country's instructions on how to dispose of used batteries.**

## ■ Precautions

**Warning:** To reduce the risk of fire or electric shock, do not expose this appliance to rain or moisture.

This Document Camera has a 3-wire AC line Plug. This is a safety feature to ensure that the plug will fit into the power outlet. Do not try to disable this safety feature.

If the Document Camera will not be used for an extended time, unplug it from the power socket.

	<p>Note</p> <p><b>Risk of Electric Shock</b> Please do not open it by yourself</p>	
<p>Caution: To reduce the risk of electric shock, do not remove cover (or back). No user-serviceable parts inside. Refer servicing to licensed service personnel.</p>		
	<p>This symbol indicates that this equipment may contain dangerous voltage which could cause electric shock.</p>	
<p>This symbol indicates that there are important operating and maintenance instructions in this User Manual with this unit.</p>		

## ■ FCC Warning

This Document Camera has been tested and found to comply with the limits for a Class A digital device, pursuant to Part 15 of FCC Rules. These limits are designed to provide reasonable protection against harmful interference in a residential installation.

## ■ EN55022 (CE Radiation) Warning

This product is intended for use in a commercial, industrial, or educational environment. It is not intended for residential use.

This is a Class A product. In a residential environment it may cause radio interference, in which case the user may be required to take adequate measures. The typical use is in a conference room, meeting room or auditorium.

# Chapter 2 Package Contents

DC170

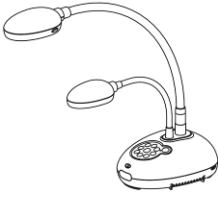

Quick Start Guide  
(For download of other language versions, please visit Lumens website)



4-Steps Card



VGA Cable



USB Cable

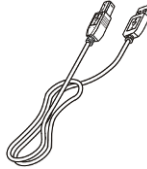

Power Cord



Appearance may vary depending on country/region

Remote Control



Remote Control Holder

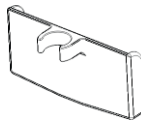

Microscope Adapter



Accessory Pouch



# Chapter 3 Product Overview

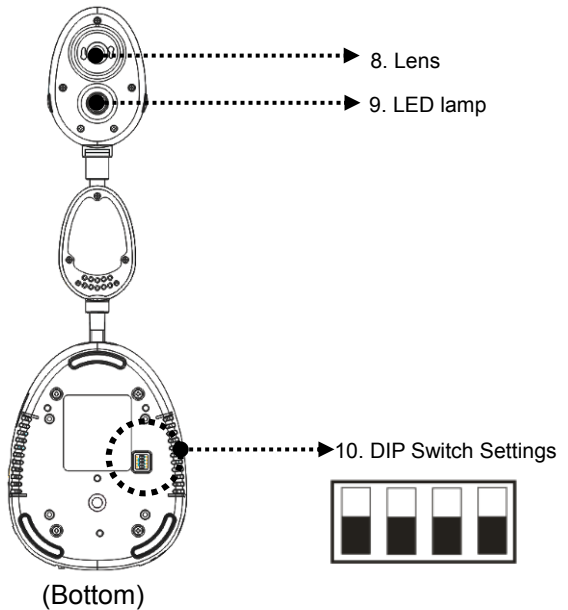
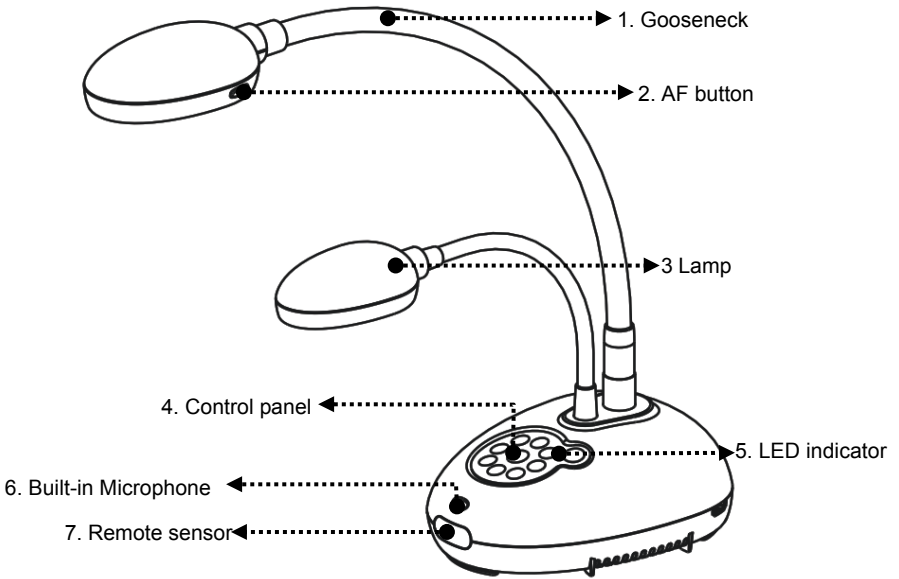



### 3.1 Relative position of the presenter and document

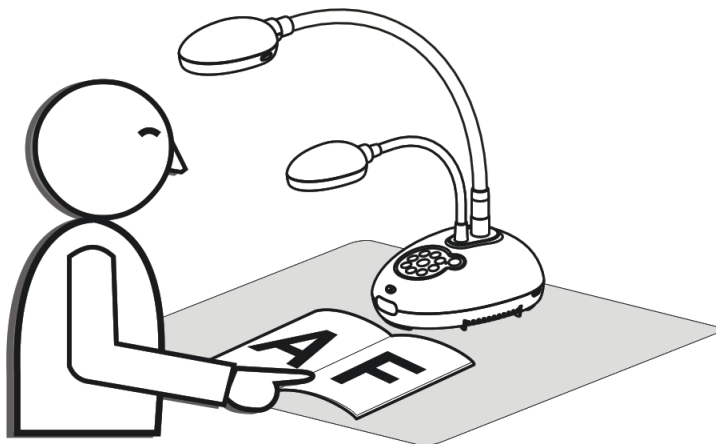

# Chapter 4 Installation and Connections

## 4.1 System diagram

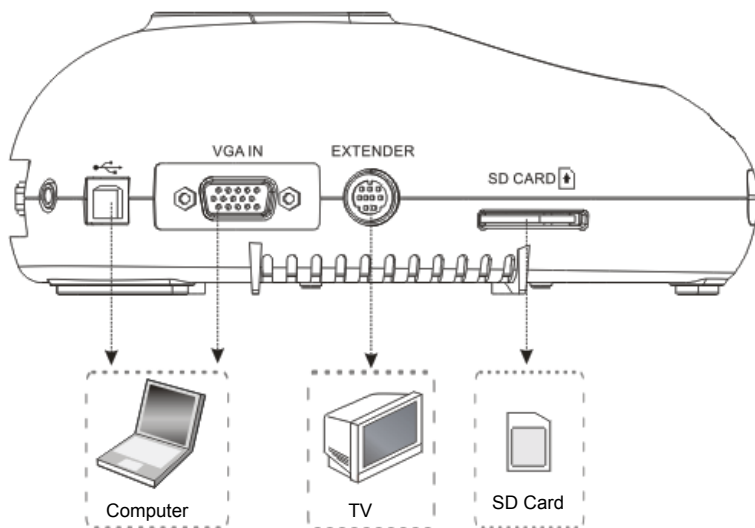
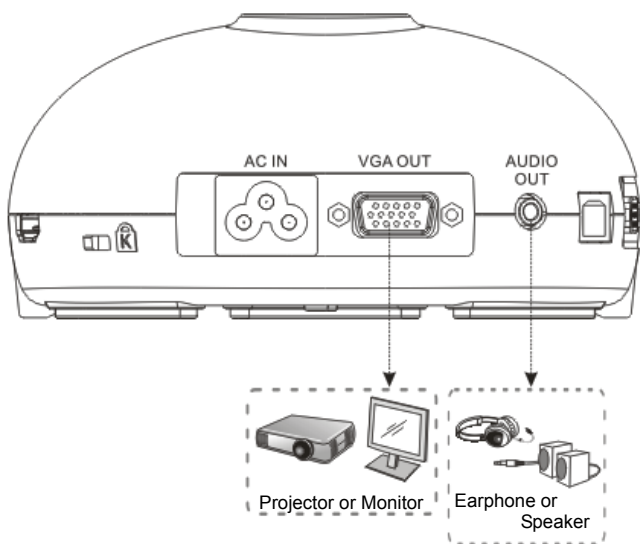

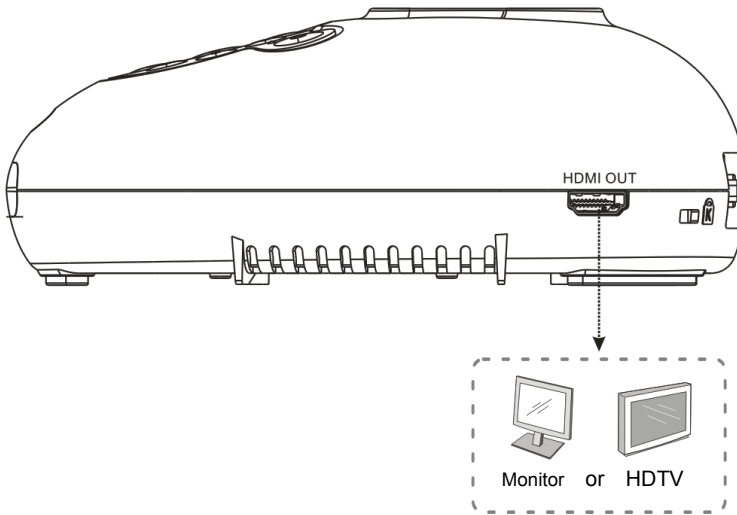

## 4.2 Installation and setup

1. Please set up the DIP Switch Settings first. Refer to [Chapter 9 DIP Switch Settings](#) in the DC190 User Manual.

## 4.3 Connecting to a projector or monitor

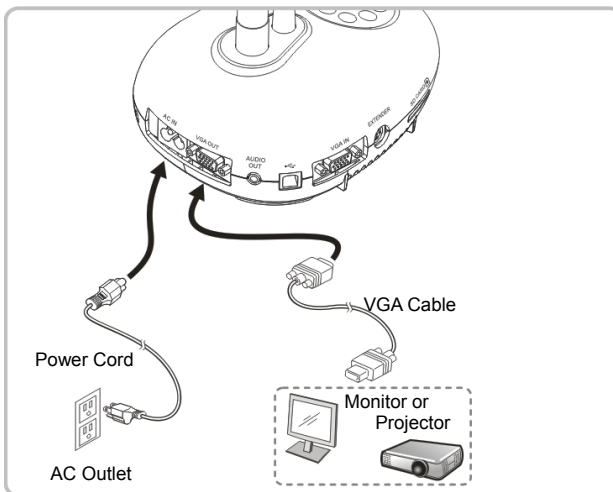

## 4.4 Connecting to a computer and use Lumens™ software

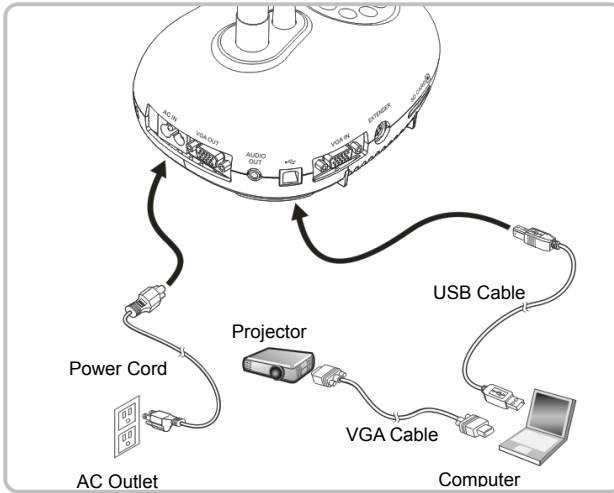

- Driver and software can be downloaded from Lumens website

## 4.5 Connecting to a computer and projector or monitor simultaneously

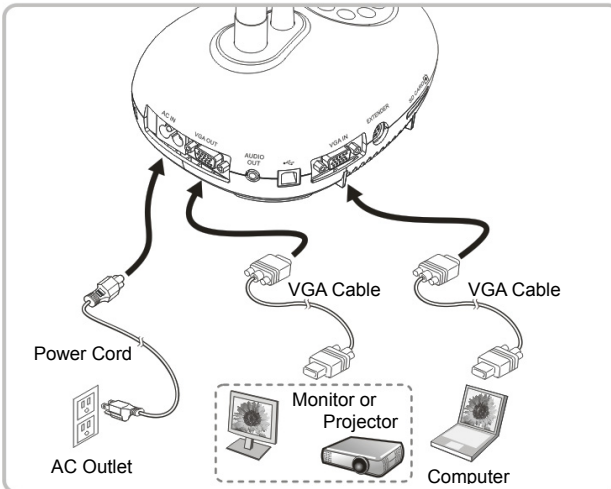

- Press [SOURCE] button to switch the image source.

## 4.6 Connect to a PC and read the SD card

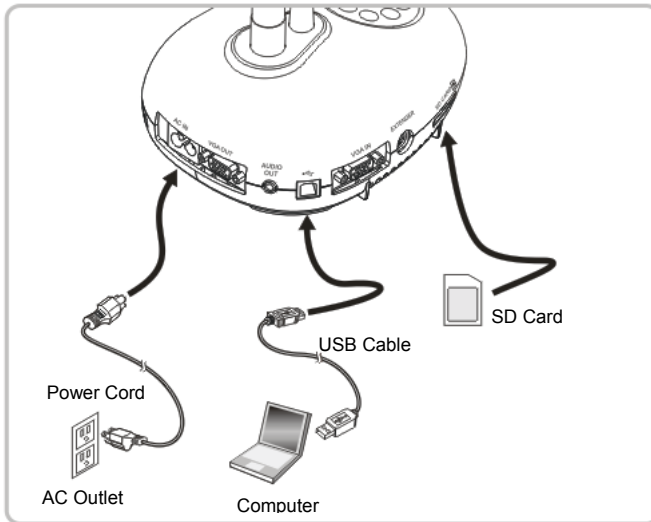

<Note> Connected to a computer and turned off, the Document Camera is just regarded as an external storage device.

## 4.7 Connecting to an Interactive Whiteboard (IWB)

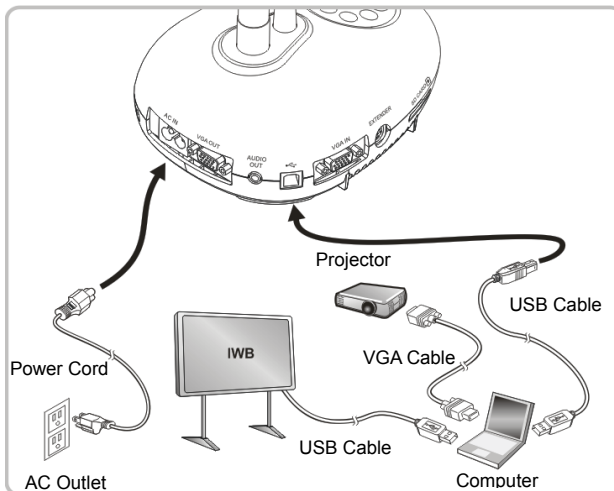

## 4.8 Connecting to an HDTV

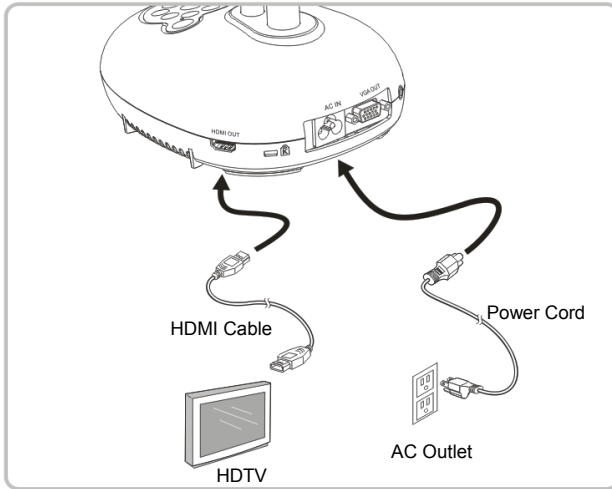

## 4.9 Connecting to a speaker

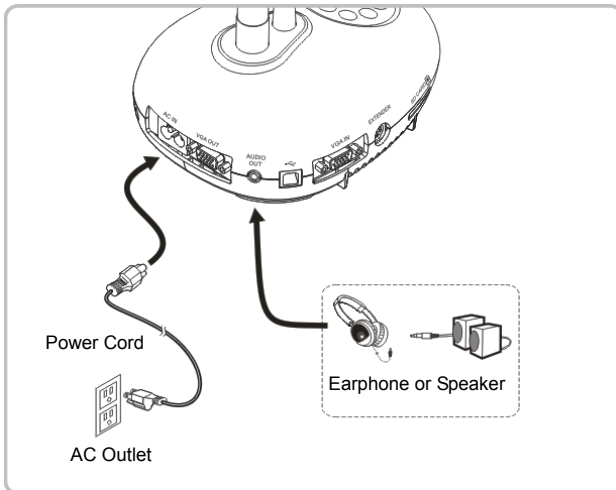

## 4.10 Connecting to a Computer with RS232

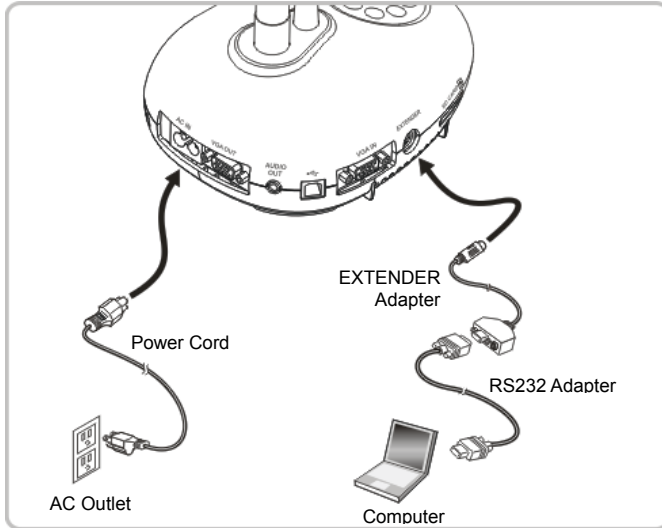

- After connecting to the RS232 cable, you can use RS232 commands to control DC170.

## 4.11 Connecting to a TV

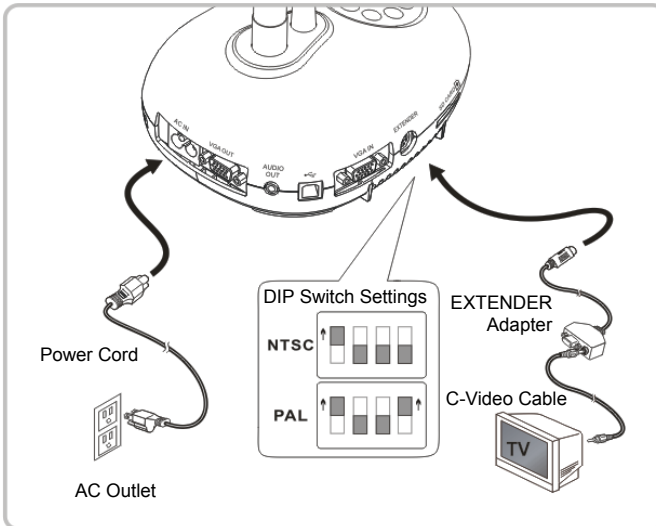

- NTSC: USA, Canada, Mexico, Panama, Chile, Japan, Taiwan, Korea, and

Philippines.

- PAL: Countries/regions not listed above.

**<Note> You should unplug and reconnect the power cord, and then restart the machine for DIP Switch Settings to take effect. Once C-VIDEO is on, VGA OUT is not supported.**

**<Note> Only the live image can be displayed in C-Video Out mode.**

## **4.12 Installing application software**

The application software installed on the computer enables you to:

- Control the DC170.
- Capture and record images.
- Annotate the image, highlight important details and save it.
- Support the full screen function.



**<Note> Please refer to [Ladibug™ software user manual](#) for installation steps and software operation.**

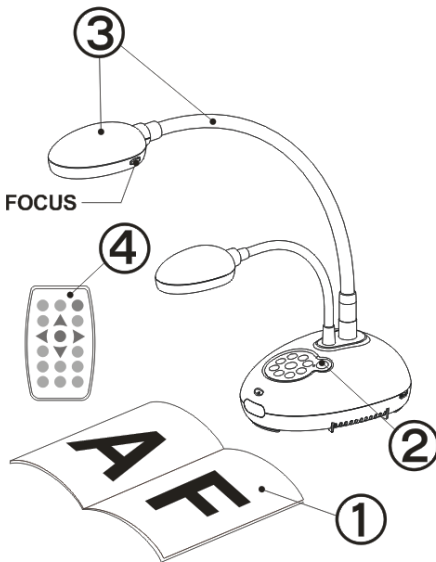

## Chapter 5 Start Using

---











1. Place an object to be displayed under the camera.
2. Turn on Power .
3. Adjust the gooseneck and lens to the appropriate positions.
4. Press [AUTO TUNE]  button to optimize the image. You are ready to teach/present.
  - Each time the camera head is moved, please locate it and then press [FOCUS] to refocus the lens.



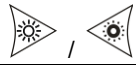





- When using the remote control, aim at the remote sensor on the DC170, and press the power button.
- Once DC170 is turned on, the LED on the control panel will flash a few times and stay lit. Please contact your distributor if the LED is not on.

# Chapter 6 Control Panel/Remote Control and Setting Menu

## 6.1 Functions of control panel and remote control

<Remark> The below functions are listed alphabetically.

Name	Function Descriptions	Operation
	Turn on and off the Document Camera.	Remote control /Control panel
◀, ▶, ▲, ▼	Move up, down, left or right to select the needed function.	Remote control /Control panel
FOCUS	AF Button.	Either sides of the lens
AUTO TUNE 	Automatically adjust the image to have the best brightness and focusing performance.	Remote control /Control panel
BRT+/- 	Adjust the brightness of the image.	Remote control
CAPTURE 	Capture images to SD card (priority) or internal memory card.	Control panel
CAPTURE /DEL 	Capture and save images to the SD Card (priority) or internal memory card while displaying live images. Delete files from the SD Card (priority) or internal memory while reading the stored files (in Playback mode).	Remote control
ENTER 	Enter/Activate functions.	Remote control
ENTER / FREEZE 	Live image: Freeze the current image OSD Mode: Enter/Activate functions	Control panel
FREEZE 	Freeze the current image to remain temporarily on the screen. Press again to defreeze.	Remote control
LAMP 	Lamp mode toggle switch.	Remote control /Control panel

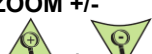













<b>MASK</b> 	Enter Mask/Spotlight mode.	<b>Remote control</b>
<b>MENU</b> 	Activate the setting menu/exit the menu.	<b>Remote control /Control panel</b>
<b>PAN</b> 	Enable/Disable the Partial Enlarged mode.	<b>Remote control</b>
<b>PIP</b> 	Image comparison (to compare live images with stored image files).	<b>Remote control</b>
<b>PLAYBACK</b> 	Read files stored in the SD Card (priority) or internal memory.	<b>Remote control /Control panel</b>
<b>RECORD</b> 	Record motion images. Press [RECORD] to record images to SD Card, and then press [RECORD] again to stop recording.	<b>Remote control</b>
<b>ROTATE</b> 	Screen rotation 0°/180°/Flip/Mirror	<b>Remote control</b>
<b>SOURCE</b> 	Switch between different sources of signals: 1. Live images (default). 2. Computer. <b>&lt;Remark&gt; This button is disabled in C-VIDEO Out mode.</b>	<b>Remote control /Control panel</b>
<b>ZOOM +/-</b> 	Increase or decrease the image size.	<b>Remote control /Control panel</b>

## 6.2 Setting Menu

### 6.2.1 Main menu

<Remark> Press [MENU] on the **remote control or control panel** to display the setting menu.



	<b>Auto Tune</b> Automatically adjust the image to have the best brightness and focusing performance.		<b>Slide Show</b> Show the photos or videos stored in the SD card (priority) or internal memory in slide mode.
	<b>PAN</b> Enable/Disable the Partial Enlarged mode.		<b>Manual Focus</b> AF Button.
	<b>LAMP</b> Lamp mode toggle switch.		<b>Rotate</b> Screen rotation 0°/180°/Flip/Mirror
	<b>PIP</b> Image comparison (to compare live images with stored image files).		<b>Settings</b> Set up various functions.
	<b>Brightness</b> Adjust the brightness of the image.		<b>Photo/Text</b> Select Photo/Text/Gray Mode.
	<b>Mask</b> Activate the mask mode.		<b>Zoom</b> Increase or decrease the image size.
	<b>Mode</b> Select image mode.		<b>Spotlight</b> Activate the spotlight mode.

## 6.2.2 Set up menu

1 <sup>st</sup> Level Major Items	2 <sup>nd</sup> Level Minor Items	3 <sup>rd</sup> Level Adjustment values	Function Descriptions
Capture	Capture Mode	<b>Single Capture</b> / Time Lapse / Record / Disable	Press left and right arrow keys to select capture mode.
	Capture Time	1. <b>1 hr</b> 2. 2 hr 3. 4 hr 4. 8 hr 5. 24 hr 6. 48 hr 7. 72 hr	Use the left and right arrow keys to select the capture time. <b>&lt;Note&gt; This will be active only when capture mode is set to timer</b>
	Capture Interval	1. 3 Sec 2. <b>5 Sec</b> 3. 10 Sec 4. 30 Sec 5. 1 Min. 6. 2 Min. 7. 5 Min.	Use the left and right arrow keys to select the capture interval. <b>&lt;Note&gt; This will be active only when capture mode is set to timer</b>
	Image Quality	1. High 2. <b>Medium</b> 3. Low	Use the left and right arrow keys to select the image quality for the captured images and recorded videos
Storage	Slide Show	<b>Enter</b>	Show the photos or videos stored in the SD card (priority) or internal memory in slide mode.
	Delay	1. 0.5 Sec 2. <b>1 Sec</b> 3. 3 Sec 4. 5 Sec 5. 10 Sec 6. Manual	Use the left and right arrow keys to select the delay time. Select manual mode to switch images manually.
	Copy To SD Card	<b>Enter</b>	Use the left and right arrow keys to select, and then press [ENTER] to confirm to copy files from internal memory to SD Card.
	Delete All	Yes/ <b>No</b>	Use the left and right arrow keys to select, press [ENTER] to confirm the deletion of all images from the SD Card (priority) or internal memory.
	Format	Yes/ <b>No</b>	Use the left and right arrow keys to select, and then press [ENTER] to format the SD Card (priority) or internal memory.

Control	Auto Exposure	<u>On</u> /Off	Regardless of outside environment, the machine will adjust the brightness to the optimal condition. Use the left and right arrow keys to select.
	Auto White Balance	<u>Enter</u>	Regardless of outside light or color, the machine will adjust the color to the optimal condition; Press [ENTER] to activate.
	Audio Volume	0~ <u>A</u> ~Max	Use the left and right arrow keys to adjust the volume.
	Projector Type	DLP/ <u>LCD</u>	Use the left and right arrow keys to select the projector type and reduce image noise.
	Digital Zoom	<u>On</u> /Off	Use the left and right arrow keys to turn on/off <b>digital zoom</b> .
Advanced	Language	<ol style="list-style-type: none"> <li>1. <u>English</u></li> <li>2. 繁體中文</li> <li>3. 简体中文</li> <li>4. Deutsch</li> <li>5. Français</li> <li>6. Español</li> <li>7. Русский</li> <li>8. Nederlands</li> <li>9. Suomi</li> <li>10. Polski</li> <li>11. Italiano</li> <li>12. Português</li> <li>13. Svenska</li> <li>14. dansk</li> <li>15. ČESKY</li> <li>16. العربية</li> <li>17. 日本語</li> <li>18. 한국의</li> <li>19. ελληνικά</li> </ol>	<p><b>English</b> 繁體中文 简体中文 Deutsch Français Español Русский Nederlands Suomi Polski Italiano Português Svenska dansk ČESKY العربية 日本語 한국의 ελληνικά</p> <p>Use the left and right arrow keys in the Language option to select the preferred language.</p>
	Lock Down	On/ <u>Off</u>	Use the left and right arrow keys to turn on/off the lock down function. You can set the password when [On] is selected.
	Auto Erase	On/ <u>Off</u>	Use the left and right arrow keys to enable/disable Auto Erase. When [On] is selected, the stored images will automatically be deleted when the system is turned off.
	Preset Load	Yes/ <u>No</u>	Read the value of the current image mode. Use the left and right arrow keys to select, and then confirm by pressing [ENTER].

	<b>Preset Save</b>	Yes/ <u>No</u>	Read the value of the current image mode. Use the left and right arrow keys to select, and then confirm by pressing [ENTER].
	<b>Splash Screen Settings</b>	<u>Enter</u>	Open Splash Screen Setting window
	<b>Factory Reset</b>	Yes/ <u>No</u>	Use the left and right arrow keys to select, and then confirm by pressing [ENTER] to restore the factory defaults.
	<b>Firmware Version</b>	NA	Display FW version

### 6.2.3 MASK Mode Setting Menu

2 <sup>nd</sup> Level Major Items	3 <sup>rd</sup> Level Minor Items	4 <sup>th</sup> Level Adjustment values	Function Descriptions
<b>MASK Mode</b>	<b>Live</b>	<u>Enter</u>	Press [ENTER] to return to live image.
	<b>Transparency</b>	0~ <u>2</u> ~3	Adjust the transparency of the mask using left and right arrow keys.
	<b>Step</b>	Large/ <u>Medium</u> /Small	Select the step distance of the mask using left and right arrow keys.
	<b>V Size</b>	0~ <u>A</u> ~Max	Adjust the vertical height of the mask using left and right arrow keys.
	<b>H Size</b>	0~ <u>A</u> ~Max	Adjust the horizontal length of the mask using left and right arrow keys.
	<b>Exit</b>	<u>Enter</u>	Press [ENTER] key to confirm your selection and exit the mask mode OSD menu.

## 6.2.4 Spotlight Mode Setting Menu

2 <sup>nd</sup> Level Major Items	3 <sup>rd</sup> Level Minor Items	4 <sup>th</sup> Level Adjustment values	Function Descriptions
Spotlight Mode	Live	<u>Enter</u>	Press [ENTER] to return to live image.
	Shape	<u>Ellipse</u> /Rectangle	Use the left and right arrow keys to select the shape of the spotlight zone.
	Transparency	0~ <u>2</u> ~3	Adjust the transparency of the border in the Spotlight mode using left and right arrow keys.
	Step	Large/ <u>Medium</u> /Small	Select the step distance of the spotlight zone using left and right arrow keys.
	V Size	0~ <u>A</u> ~Max	Adjust the height of the spotlight zone using left and right arrow keys.
	H Size	0~ <u>A</u> ~Max	Adjust the width of the spotlight zone using left and right arrow keys.
	Exit	<u>Enter</u>	Press [ENTER] key to confirm your selection and exit the spotlight mode OSD menu.

## 6.2.5 Splash Setting Windows

2 <sup>nd</sup> Level Major Items	3 <sup>rd</sup> Level Minor Items	4 <sup>th</sup> Level Adjustment values	Function Descriptions
Splash Screen Setting	Power On Image Setting	<u>Default</u> /Customer	Select Default/Customer power on image
	Power On Logo Show Time	4 ~ 30 seconds	Set up Image display time
	Power On Image Select	<u>Enter</u>	Select Power On Image. Only pictures in JPEG format are supported
	Exit	<u>Enter</u>	Press [ENTER] key to confirm your selection and exit Splash Screen Settings window.



# Chapter 7 Descriptions of major functions

---

## 7.1 I would like to automatically adjust the image to have the best brightness and focusing performance

Use the remote control or control panel:

1. Press [AUTO TUNE] for the optimal brightness and focal length.

## 7.2 I would like to switch image sources

**Live image** is the default image source. Press [SOURCE]  on the **remote control** or **control panel** to have DC170 switch among the following images sources:

1. Live images (default).
2. Computer.

<Remark> This image switch applies to VGA OUT only.

## 7.3 I would like to switch the image mode

Use the remote control or control panel:

- 1 Press [MENU] to enter the setting menu.
- 2 Press [▲], [▼], [▶], or [◀] to select [Image mode].
- 3 Press [▶] or [◀] to the [Normal/Film/Slide/Microscope].
- 4 Press [MENU] to exit.

## 7.4 I would like to make text clearer and photos more colorful

### 7.4.1 Photo/Text mode descriptions

The default [Photo/Text] mode is in Photo (**Photo mode**). To change this setting, please use the **remote control** or the **control panel** to enter the Options of the Setting Menu.

- [Photo] (default): for viewing photos or text with photos, making photos more colorful.
- [Text]: for viewing text files, making the text clearer.
- [Gray]: for viewing black & white photos which will make the grayscale differentiation distinct.

## 7.4.2 Setting Photo/Text mode

To change the settings, please use the **remote control** or the **control panel**:

1. Press [MENU] to enter the setting menu.
2. Press [▲], [▼], [▶], or [◀] to select [Photo/Text]. (Please refer to [7.4.1 Photo/Text mode descriptions](#) to make the best choice.)
3. Press [ENTER] key to enter.
4. Press [▶] or [◀] to select the [Photo/Text/Gray].
5. Press [MENU] to exit.

## 7.5 I would like to zoom in/out images

1. Press [ZOOM+] on the **remote control** or **control panel** to zoom in images.
2. Press [ZOOM-] on the **remote control** or **control panel** to zoom out images.

## 7.6 I would like to use the auto focus

1. Press the [FOCUS] AF button on the right side of the lens.

## 7.7 I would like to adjust the brightness

### Remote control:

1. Press [BRT +] to make it brighter.
2. Press [BRT -] to make it darker.

### Control panel:

1. Press [MENU] to enter the setting menu.
2. Press [▲], [▼], [▶], or [◀] to select [Brightness].
3. Press [ENTER] key to enter.
4. Press [▶] or [◀] to adjust the brightness.
5. Press [MENU] to exit.

## 7.8 I would like to turn on/off the lamp

The default of the lamp is **OFF**. When using the **remote control** or **control panel**:

1. Press [LAMP] to switch ON/OFF. (The sequence of switching is: OFF/Arm light/Dual light/Head light)

## 7.9 I would like to freeze images

1. Press [FREEZE] on the **remote control** or **control panel** to freeze the current image on the screen. Press again to defreeze.

## 7.10 I would like to rotate the image

### Remote control:

1. Press [ROTATE] key to turn the screen. (The sequence of switching is: 0°/180°/Flip/Mirror)

### Control panel:

1. Press [MENU] to enter the setting menu.
2. Press [▲], [▼], [▶], or [◀] to select [Rotate].
3. Press [ENTER] key to enter.
4. Press [▶] or [◀] to toggle switch rotation model. (The sequence of switching is: 0°/180°/Flip/Mirror)
5. Press [MENU] to exit.

## 7.11 I want to capture images

### 7.11.1 Capture and save images

1. Press [CAPTURE] on the **remote control** or **control panel** to capture and save images.
  - You cannot capture images when the capture mode is set to [Disable]. If it is set to [Continuous], you can capture images continuously. Press [Capture] to start capturing continuously, or press [Capture] again to exit.
  - To change the quality of captured images, please refer to [7.11.2 Setting the quality of captured images](#).
  - To change the settings of captured images, please refer to [7.11.3 Setting continuous capture](#).

### 7.11.2 Setting the quality of captured images

1. Press [Menu] on the **remote control** or **control panel** to enter the setting menu.
2. Press [▲], [▼], [▶], or [◀] to select [Setting].
3. Press [ENTER] key to enter.

4. Press [▶] or [◀] to the [Capture] menu.
5. Press [▼] to find [Image Quality].
6. Press [▶] or [◀] to select among [High/Medium/Low].
7. Press [Menu] to exit.

### 7.11.3 Setting continuous capture

1. Press [MENU] on the **remote control or control panel** to enter the setting menu.
2. Press [▲], [▼], [▶], or [◀] to select [Setting].
3. Press [ENTER] key to enter.
4. Press [▶] or [◀] to the [Capture] menu.
5. Press [▼] to the [Capture Mode].
6. Press [▶] or [◀] to select [Timer].
7. Press [▼] to find [Capture Time]; Press [▶] or [◀] to set capture time.
8. Press [▼] to find [Capture Interval]; Press [▶] or [◀] to set interval time.
9. Press [MENU] to exit.

## 7.12I would like to record videos

< Note > Connect SD card to DC170 to start recording images.

### 7.12.1 Recording motion images

<Remark> You may not be able to capture or record images when [Capture Mode] is set to [Disable].

**Remote control:**

1. Press [RECORD] on the **remote control** to start recording videos.
2. Record sounds with the built-in microphone of the control panel.
3. Press [RECORD] again to stop recording.

**Control panel:**

1. Press and hold [CAPTURE] for about 2 seconds to start recording videos.
2. Press [CAPTURE] again to stop recording.

### 7.12.2 Setting the quality of captured images

1. Press [Menu] on the **remote control or control panel** to enter the setting menu.
2. Press [▲], [▼], [▶], or [◀] to select [Setting].

3. Press [ENTER] key to enter.
4. Press [▶] or [◀] to the [Capture] menu.
5. Press [▼] to find [Image Quality].
6. Press [▶] or [◀] to select among [High/Medium/Low].
7. Press [Menu] to exit.

### 7.12.3 Recording setup

1. Press [MENU] on the **remote control** or **control panel** to enter the setting menu.
2. Press [▲], [▼], [▶], or [◀] to select [Setting].
3. Press [ENTER] key to enter.
4. Press [▶] or [◀] to the [Capture] menu.
5. Press [▼] to the [Capture Mode].
6. Press [▶] or [◀] to select [Record].
7. Press [MENU] to exit.

**<Remark> When [Capture Mode] is set to [Record], the function of [CAPTURE] on the Control Panel is changed to Image Recording.**

### 7.12.4 Playing videos

- For playing videos, please refer to [7.13 I would like to view captured/recorded images.](#)

## 7.13 I would like to view captured/recorded images

1. Press [PLAYBACK] on the **remote control** or **control panel** to display thumbnails of all stored files.
2. Press [▲], [▼], [▶], or [◀] to select the thumbnail you want to play.
3. Press [ENTER] for full-screen play.
4. When the Video is played, it can be Paused/Played by pressing [Freeze].
5. Press [▶] or [◀] to select the next or previous Audio/Video File.
6. Press [▲] or [▼] to adjust the volume of the video.
7. Press [PLAYBACK] to return to the Thumbnail Mode to select other Audio/Video Files, or press [MENU] to exit.

**<Note> An external speaker must be connected to AUDIO OUT to play sound when you use VGA OUT.**

## 7.14 I would like to delete the captured/recorded images

### Use Remote control:

1. Press [PLAYBACK] to show the thumbnails of all stored files.
2. Press [▲], [▼], [▶], or [◀] to select the file you want to delete.
3. Pressing [DELETE] will open a [Delete File] window.
4. Press [▶] or [◀] to select [Yes].
5. Press [ENTER] to delete the selected file.
6. Press [MENU] to exit.

## 7.15 I would like to automatically delete the stored images whenever it is turned off (Auto Erase)

### Use the remote control or control panel:

1. Press [MENU] to enter the setting menu.
2. Press [▲], [▼], [▶], or [◀] to select [Setting].
3. Press [ENTER] key to enter.
4. Press [▶] or [◀] to the [Advanced] menu.
5. Press [▲] or [▼] to [Auto Erase].
6. Press [▶] or [◀] to select [On].
7. Press [MENU] to exit.

## 7.16 I would like to enlarge a part of the image (PAN)

### Remote control:

1. Press [PAN] to enter the Partial Enlarged mode.
2. Press [▲], [▼], [▶], or [◀] to move and view the partial enlarged images.
3. Press [PAN] to exit the partial enlarged mode.

### Use control panel:

1. Press [MENU] to enter the setting menu.
2. Press [▲], [▼], [▶], or [◀] to select [PAN].
3. Press [ENTER] to activate.
4. Press [▲], [▼], [▶], or [◀] to move and view the partial enlarged images.
5. Press [MENU] to exit the partial enlarged mode.

## 7.171 I would like to use the MASK and Spotlight function

### 7.17.1 I would like to use the MASK or Spotlight mode

#### Use Remote Control:

1. Press [MASK] key to enter the Mask/Spotlight mode menu. Press [◀] or [▶] to select mode.
2. Press [▲] or [▼] or [◀] or [▶] to move the zone position.
3. Press [MASK] again to exit and return to the live image screen.

#### Use control panel:

1. Press [MENU] to enter the setting menu.
2. Press [▲] or [▼] or [◀] or [▶] to select [Mask], Press [ENTER] to enter mask mode or select [Spotlight] and press [ENTER] key to enter Spotlight mode.
3. Press [MENU] to enter the image OSD menu.
4. Press [▲] or [▼] to select [Live].
5. Press [ENTER] to return to Live Image.

### 7.17.2 I would like to set the size of Mask

#### I would like to use the Remote under the mask mode:

1. Press [MENU] to enter the image OSD menu.
2. Press [▲] or [▼] to select the item to be modified [Transparency/Step/V Size/H Size]. (For details, please refer to [6.2 Setting Menu.](#))
3. Press [◀] or [▶] to perform the modification.
4. Press [MENU] to exit the image OSD menu and return to the Mask mode.

### 7.17.3 I would like to set Spotlight function

#### Use the Remote under Spotlight mode:

1. Press [MENU] to enter the image OSD menu.
2. Press [▲] or [▼] to select the item to be modified [Shape/Transparency/Step/V Size/H Size]. (For details, please refer to [6.2 Setting Menu.](#))
3. Press [◀] or [▶] to perform the modification.
4. Press [MENU] to exit the image OSD menu and return to Spotlight mode.

## 7.18I would like to play the slides (Slide Show)

### 7.18.1 Setting delay time

1. Press [MENU] on the **remote control** or **control panel** to enter the setting menu.
2. Press [▲], [▼], [▶], or [◀] to select [Setting].
3. Press [ENTER] key to enter.
4. Press [▶] or [◀] to the [Storage] menu.
5. Press [▼] to find [Delay].
6. Press [▶] or [◀] to select image switch mode between [0.5 Sec/1 Sec/3 Sec/5 Sec/10 Sec/Manual].
7. Press [MENU] to exit.

### 7.18.2 Activating/Pausing/Stopping the slide show

<Note> Upper Limit: The maximum size of single photo is 7 MB.

#### If you use the remote control or the control panel

1. Press [MENU] to enter the setting menu.
2. Press [▲], [▼], [▶], or [◀] to select [Slide Show].
3. Press [ENTER] to play.
4. Press [ENTER] again to Pause/Play.
5. Press [MENU] to exit.

## 7.19I would like to compare images (compare live images with stored images (PIP))

This function will compare and contrast a live image with a stored image.

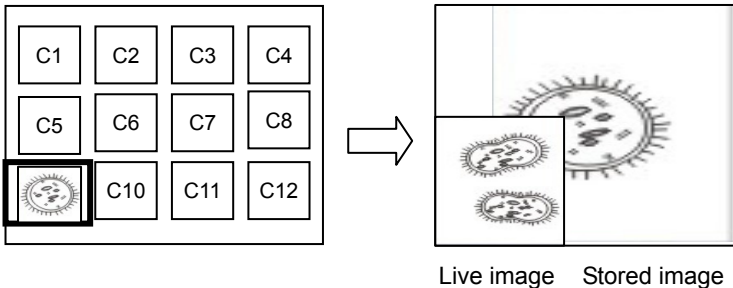

#### Remote control:

1. Press [Playback] to enter the Playback image thumbnails.



2. Press [▲], [▼], [◀], or [▶] to select the file to be compared.
3. Press [PIP] to activate image comparison.
4. Press [▲], [▼], [◀], or [▶] to move the live image.
5. Repeat Steps 1 - 3 to change other image files.
6. Press [MENU] to exit.

## 7.20I would like to reduce the image noise (Projector Type)

1. This function enables Document Camera to automatically clear image noise. The noise is especially obvious when Document Camera is connected to a DLP projector. You can set the DLP projector to improve the image quality.
2. If there is special noise when VGA out is connected, please set DLP option to improve the image quality.

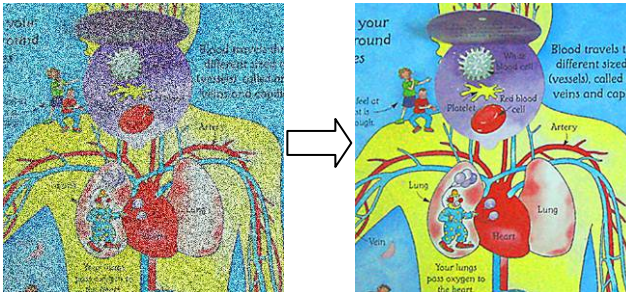

- 2.1. Press [MENU] on the **remote control** or **control panel** to enter the setting menu.
- 2.2. Press [▲], [▼], [▶], or [◀] to select [Setting].
- 2.3. Press [ENTER] key to enter.
- 2.4. Press [▶] or [◀] to select [Control].
- 2.5. Press [▼] to enter [Projector Type].
- 2.6. Press [▶] or [◀] to select [LCD/DLP].
- 2.7. Press [MENU] to exit.

## 7.21I would like to resume the factory default settings (Factory Reset)

### 7.21.1 Using OSD menu

1. Press [MENU] on the **remote control** or **control panel** to enter the setting menu.

2. Press [▲], [▼], [▶], or [◀] to select [Setting].
3. Press [ENTER] key to enter.
4. Press [▶] or [◀] to select [Advanced] menu.
5. Press [▼] to select [Factory Reset].
6. Press [▶] or [◀] to select [Yes].
7. Press [ENTER] to activate.

### 7.21.2 Use Compound Key

1. Use the **Control panel**, and press [ENTER] + [MENU] simultaneously to restore the initial value.

**<Note> Before using the compound keys, please remove all VGA-IN devices.**

## 7.22 I would like to change the splash screen

**<Note> The splash file must be less than 5 MB and in JPEG format.**

**<Note> To save the file, please follow the instruction below:**

File path: \DCIM\100MEDIA, for example: J: \DCIM\100MEDIA

File name: four English letters+ four numbers, for example: LUMN0001.JPG

1. Press [Menu] on the remote control or control panel to enter the setting menu.
2. Press [▲], [▼], [▶], or [◀] to select [Setting].
3. Press [ENTER] key to enter.
4. Press [▶] or [◀] to select [Advanced] menu.
5. Press [▼] to select [Splash Screen Settings].
6. Press [ENTER] key to enter.
7. Press [▲] or [▼] to enter the [Power On Image Setting] menu and press [▶] or [◀] to select [Default/Custom].
8. Press [▲] or [▼] to enter the [Power On Logo Show time] menu and press [▶] or [◀] to set up display time span.
9. Skip to Step 12 if your select [Default] in Step 7.
10. Press [▲] or [▼] to enter the [Power On Image Select] menu and press [ENTER] to read selected file.
11. Select [YES] to confirm the modification.
12. Press [▼] to display the [Exit] dialog box and press [ENTER] key to exit.

## 7.23I would like to use a SD card

1. After the SD card is inserted, the [Copy To SD Card] dialog box will be displayed for you to select to copy files in DC170 to SD card.
  - Press [▶] or [◀] on the **remote control** or **control panel** to select.



## 7.24 Computer-related functions

Ensure that the USB cable is connected and the drivers are installed before using the computer-related functions. Refer to [Chapter 4 Installation and Connections](#) in this User Manual.

### 7.24.1 I would like to insert a photo in MS-Paint

1. Click [File/From Scanner or Camera] in MS-Paint as shown in the bottom left figure.

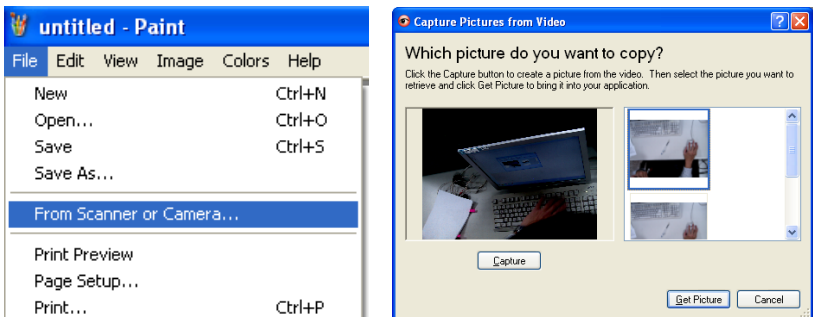

2. Click [Get Picture] will capture the photos of live images and insert the files in use shown as top right figure.

**<Remark> Support Windows XP Operation System only.**

### 7.24.2 I would like to insert images in Photoshop

1. Click [File/Import/WIA Support] in **Photoshop**.

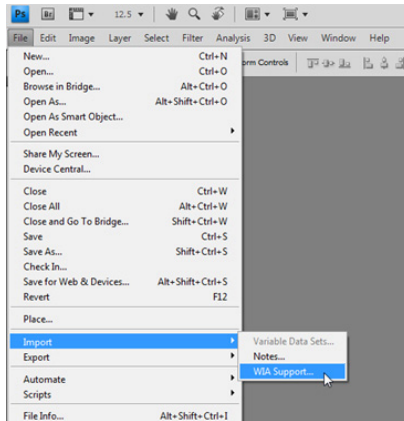

2. Complete by clicking [Capture], then clicking [Get Picture].

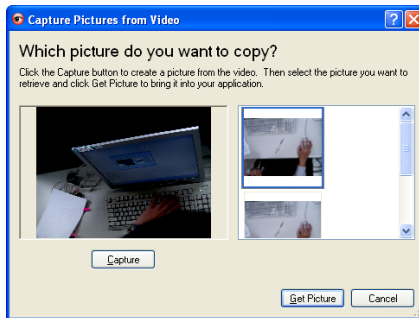

### 7.24.3 I would like to set the DC170 as a PC Camera

<Remark> For Windows XP, please set by system name (USB video device)

Open [My Computer] and click [Lumens Document Camera] to open a live image.

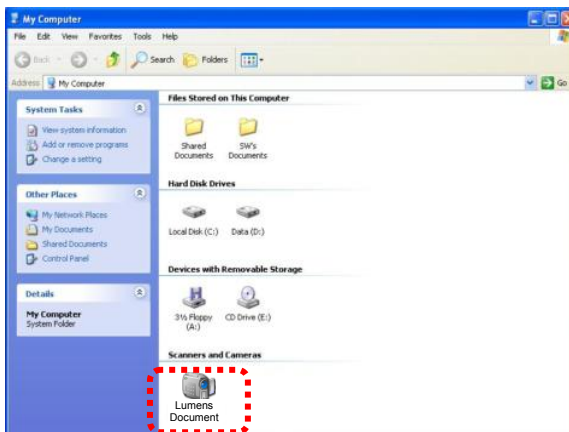

# Chapter 8 Connecting to Microscope

---

1 Mount the **microscope adapter** onto the microscope.

<Note> The **Microscope adapter accessories** are applicable to eyepieces of about **Ø28.4mm**.

2 Connect the lens of DC170 with the **microscope adapter**

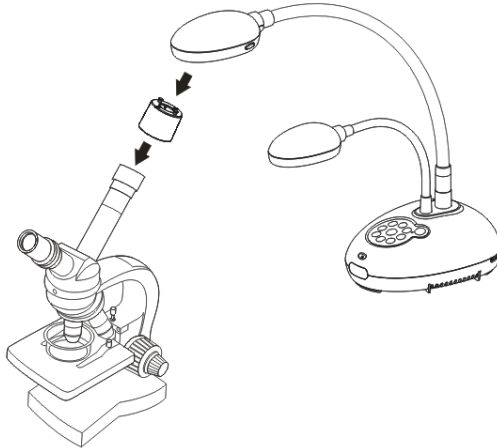

3 Select the [Microscope] mode

3.1. When using the **control panel** or **remote control**

3.1.1. Press [MENU] to enter the setting menu.

3.1.2. Press [▲], [▼], [▶], or [◀] to select [Image mode].

3.1.3. Press [▶] or [◀] to the [Microscope].

3.1.4. Press [MENU] to exit.

4 If the image is not clear

4.1. Please adjust the focus of microscope.

4.2. Please press the [FOCUS] button on either side of the DC170 lens to activate the auto focus.

5 Digital Zoom

5.1. Press [MENU] to enter the setting menu.

5.2. Press [▲], [▼], [▶], or [◀] to select [Setting].

5.3. Press [▶] or [◀] to the [Control].

5.4. Press [▼] to select [Digital Zoom].

5.5. Press [▶] or [◀] to the [On].

5.6. Press [MENU] to exit.

# Chapter 9 DIP Switch Settings

---

<Note> You should unplug and reconnect the power cord, and then restart the DC170 for all DIP Switch Settings to take effect.

## 9.1 Connecting to a projector or monitor

### 9.1.1 XGA output (default values):

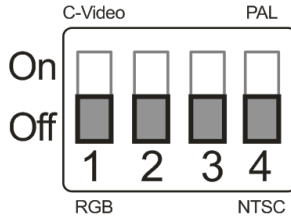

### 9.1.2 SXGA output

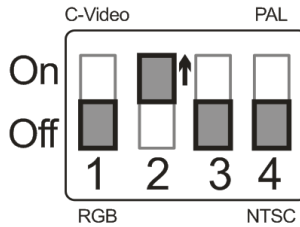

### 9.1.3 WXGA output

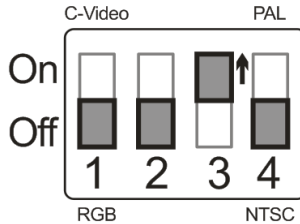

### 9.1.4 1080P output

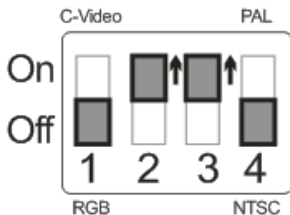

## 9.2 Connecting to a TV

### 9.2.1 NTSC: USA, Taiwan, Panama, Philippines, Canada, Chile, Japan, Korea, and Mexico.

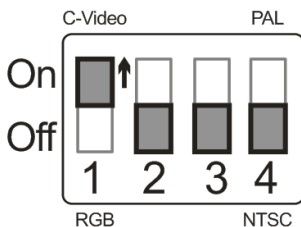

### 9.2.2 PAL: Countries/regions not listed above.

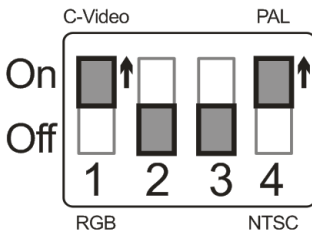

<Remark> Once C-VIDEO is on, VGA OUT is not supported.

# Chapter 10 Troubleshooting

This chapter describes problems you may encounter while using DC170. If you have questions, please refer to related chapters and follow all the suggested solutions. If the problem still occurred, please contact our distributors or service center.

No.	Problems	Solutions
1	<b>Boot without power signal</b>	Make sure you have plugged in the power cord.
2	<b>There is no image output from DC170</b>	<ol style="list-style-type: none"><li>1. Check the power.</li><li>2. Check all cable connections. Refer to <a href="#">Chapter 4 Installation and Connections</a> in this manual.</li><li>3. Check the [Source], refer to <a href="#">7.2 I would like to switch image sources of Chapter 7 Descriptions of major functions</a>.</li><li>4. Check the settings for the source of the projector. For the appropriate input selection of the projector, refer to the projectors user manual.</li><li>5. Check if DIP Switch is properly set. Refer to <a href="#">Chapter 9 DIP Switch Settings</a> for related settings.</li></ol>
3	<b>Unable to focus</b>	Probably the document is too close. Press [ZOOM -] on the <b>remote control</b> or <b>control panel</b> . Or pull away the lens from the document to increase the distance, and then press the [FOCUS] button on the right side of the lens.
4	<b>The image is incomplete</b>	Check the Auto Image setting of your projector. Please refer to the user manual of the projector or check for the DIP SWITCH settings.
5	<b>Lumens Document Camera, Ladibug™ and other applications cannot be used simultaneously</b>	<b>Lumens Document Camera, Ladibug™</b> and other applications cannot be executed simultaneously. Only one application can be executed at a time. Please close the currently running applications and then execute the application to be used.
6	<b>When the unit is turned on, the auxiliary floodlight do not light</b>	Please make sure the arm lamp is set to “OFF”. For the switch-on or -off of arm lamp, please refer to <a href="#">7.8 I would like to turn on/off the lamp of Chapter 7 Descriptions of major functions</a> .
7	<b>DC170 fails to store images or react</b>	<ol style="list-style-type: none"><li>1. Check to see if the stored data have reached the maximum size of the SD Card (priority) or internal memory.</li><li>2. Please make sure if the Capture function is set to Continuous mode or the time for capture is set to be long. For the related setting, refer to <a href="#">7.11 I would like</a></li></ol>



		<a href="#">to capture images of Chapter 7 Descriptions of major functions.</a>
8	The images outputted from DC170 are too bright, dark or vague	Press [AUTO TUNE] to automatically adjust to the optimal brightness and focal length.
9	Unable to record images	<ol style="list-style-type: none"> <li>1 Check to see if the stored data have reached the maximum size of the SD Card.</li> <li>2 The recording to internal memory is not supported. Please make sure a SD card is inserted prior to video recording.</li> </ol>
10	The operating steps in the manual are not applicable to the machine	<p>The operating steps in the manual may be not applicable to the machine due to improvement in functions. Check to see if the Firmware version of your machine is up-to-date.</p> <ol style="list-style-type: none"> <li>1 Please go to Lumens official website to check whether the latest version is available for update. <a href="http://www.Mylumens.com/goto.htm">www.Mylumens.com/goto.htm</a></li> <li>2 The steps to check the FW version are as below: <ol style="list-style-type: none"> <li>2.1 Press [MENU] on the remote control or control panel to enter the setting menu.</li> <li>2.2 Press [▲], [▼], [▶], or [◀] to select [Setting].</li> <li>2.3 Press [ENTER] key to enter.</li> <li>2.4 Press [▶] or [◀] to select [Advanced] menu.</li> <li>2.5 View [Firmware Version].</li> </ol> <p>If you are not sure whether it is the latest version, please consult your distributor for advice. <a href="http://www.Mylumens.com/en/Request_form.php">http://www.Mylumens.com/en/Request_form.php</a></p> </li> </ol>
11	How to unlock the locked device	<ol style="list-style-type: none"> <li>1. Press [Menu] on the <b>remote control or control panel</b> to enter the setting menu.</li> <li>2. Press [▲], [▼], [▶], or [◀] to select [Setting].</li> <li>3. Press [ENTER] key to enter.</li> <li>4. Press [▶] or [◀] to select [Advanced] menu.</li> <li>5. Press [▼] to [Lock Down].</li> <li>6. Press [▶] or [◀] to select [Off] and deactivate the password setting function.</li> </ol>
12	The data in the SD card cannot be read.	<ol style="list-style-type: none"> <li>1. The SD card with the capacity of 4 G and above is recommended (up to 32 G supported)</li> <li>2. Please make sure the file was saved at the specified path: \DCIM\100MEDIA. (E.g.: J: \DCIM\100MEDIA)</li> <li>3. Please make sure the file is named appropriately, e.g. four English letters + four numbers. (E.g.: LUMN0001.JPG)</li> </ol>